

BEF320-3A

Operating Manual

This manual is provided to persons purchasing an SPE machine and may not be reproduced in part or full without written permission of SPE International Ltd.

This manual provides the basic information required and is only to be used as a guideline. The SPE machines are manufactured and covered by SPE design registrations granted and pending. SPE International Ltd reserves the right to alter the equipment design and specification as required without notice.

The SPE product range is subject to amendment and improvement as a result of ongoing research.

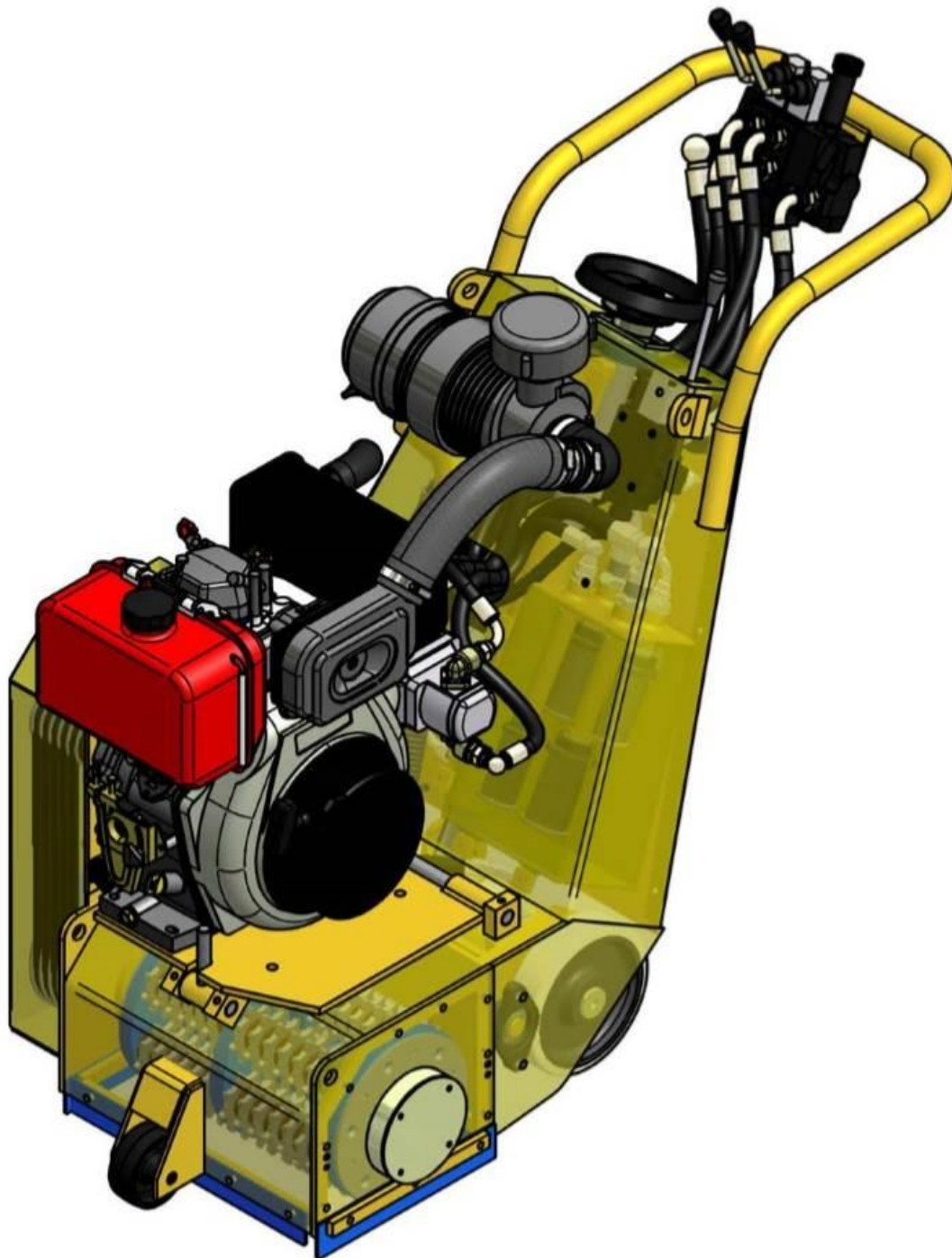



BEF320-3A
Operating Manual

BEF320-3A

OPERATING MANUAL

This manual covers to the best of our knowledge, the operation and maintenance of the BEF320 Multi-plane. Before operation of the equipment the operating manual must be read and understood by the operator. The safety regulations must be followed at all times. Service of engine and hydraulic components should be carried out by authorised personnel. Failure to follow these instructions could result in damage to the machine and/or serious personal injury or death.

WARNING

Failure to follow this instruction may result in serious personal injury or death. SPE disclaims all responsibility for damage to persons or objects arising as a consequence of incorrect handling of the machine, failure to inspect the machine for damage or other faults that may influence the operation prior to starting work, or failure to follow the safety regulations listed or applicable to the job site.

INDEX

| Page No | |
|---------|------------------------------------|
| 1 | Starting Work |
| 2 | General Operation Dust Control |
| 3-4 | Maintenance |
| 5 | Basic Maintenance Checklist |
| 6 | Safety |
| 7-8 | Accessories |
| 9-11 | Cutter Drum Set Up |
| 12 | Spare Parts Breakdown |
| 13 | Body Components |
| 14 | Undercarriage Components |
| 15 | Height Adjuster Components |
| 16 | Drum Drive Components |
| 17 | Hydraulic Tank Components |
| 18 | Hydraulic Drive Components |
| 19 | Height Control Components |
| 20 | Motor Drive Components |
| 21 | Hydraulic Flow and Main Components |
| 22 | Yanmar Engine Components |
| 23 | Specifications |
| 24 | Noise/Vibration Assessment |
| 25 | Warranty |
| 26-28 | Declaration of Conformity |
| 29 | Conditions of Sale |



STARTING WORK

CHECK the following prior to starting the equipment:

- Check condition of cutter drum assembly
- Check all bolts for tightness
- Check drive belt condition and tension
- Check drive pulleys are undamaged and clean
- Check engine oil level
- Check air filter is clean

1. BEFORE starting the machine ensure the cutter drum assembly is clear of the ground. If not adjust using hand wheel.
2. ENSURE the drive control levers are in the non-drive/neutral (central) position and speed control knob is turned to OFF position.
3. Connect vacuum hose to dust port at side of machine if dust control vacuum is being used.
4. START the engine – see operators manual
5. OPERATE the hydraulic lift/lower lever allowing the machine to fall to its lowest position
6. SLOWLY rotate the hand wheel until the cutters make contact with the surface to be treated.
7. Push both drive control levers forward and slowly open the speed control knob until machine is moving at satisfactory speed.
8. Adjust hand wheel to desired cutting depth and engage hand wheel locking pin.
9. To raise and lower machine use hydraulic lift lever to the left of hand wheel.
10. To turn machine around at end of run raise out of cut, reduce forward speed and pull either drive control lever back through neutral and into reverse. Pulling the left lever will make machine turn left and the right one turn right.



GENERAL OPERATION

It is essential that the cutters are not lowered too far and too hard onto the surface as serious damage could be caused to the machine and cutter drum assembly.

THE cutters must be allowed to "float" on the cutter shafts without excessive downward pressure. This floating action allows the cutters to perform as the designer intended i.e. as cutters rather than as grinders or picks. Do not pull the control levers into reverse when cutting as this could result in the machine reversing quickly in an uncontrolled manner.

The machine should operate smoothly with a minimum of vibration. When the depth of cut is correctly set very little effort should be required to operate the machine.

EXCESSIVE downward pressure on the cutters may marginally improve the work rate/finish but the definite increase in wear rates on the cutter drum assembly and machine components is the negative result. Remember two light passes are quicker and more cost effective than one slow heavy pass. Tests have proven conclusively that heavy downward pressure reduces cutter and drum life by over 50%.

The BEF320 should always be operated in a forward direction. The operator varies the speed of travel to determine the final finish having already pre-set the depth control. It is recommended that the machine is not operated in reverse whilst the cutters are in contact with the surface. When lifting the cutter drum from the work surface it is not necessary to turn the hand wheel - lift upwards by simply operating the hydraulic lift lever.

The BEF320 machine should always be moved by its own hydraulic power-driven system as pushing the machine continually around by hand could result in internal damage to the hydraulic motor and pump system.

This manual should be read in conjunction with the owner's manual of the diesel engine. The engine is designed to give safe and dependable service if operated according to the instructions. Read and understand the owner's manual before operating the engine. Failure to do so could result in personal injury or equipment damage.

DUST CONTROL

To control any dust created by the operation connect an industrial dust collector or vacuum to the 50mm port at the side of the machine. We recommend the SPE 316 for almost 100% dust control. In the absence of a dust control unit it is acceptable to spray water onto the surface or to feed water down the vacuum port. Cutter drum assembly life is increased by around 10% when operating the machine in this way.



MAINTENANCE

PRIOR TO ANY MAINTENANCE OR ADJUSTMENT STOP ENGINE.

After use: Clean the machine to remove all build up of dust and surface residues.

Drum Removal:

Remove bolts on side plate and then screw two bolts back into the two tapped holes in the side plate. Continue winding in and this will push side plate off dowel pins. Pull off side plate remove key from shaft. Pull out cutting drum. Fitting a new cutter head is simply a reversal of the above procedure, a little care must be taken to align the drive shaft, cutter drum and support end drive bush.

EXCESSIVE FORCE SHOULD NOT BE NEEDED TO REFIT THE CUTTER DRUM.

Cutter Drum Maintenance:

When changing cutter drum always check that the flail shafts are not worn with pronounced grooves and also that the centres of cutters and spacers are not elongated and beginning to "mushroom". The drum assembly is hitting concrete with great force 650 times every minute! Expenditure on consumables must be expected and built into all job costing.

While changing the drum the condition of the drive shaft and side plate bearings should be checked. If any roughness, side play or leakage of grease is detected then new bearings should be fitted. Lightly oiling the drive shaft will prevent a build-up of rust which could cause difficulty when changing the drum. At the same time check belt tension and condition also checking the pulley grooves are clean and undamaged.

The drive shaft is manufactured from high quality steel to produce the special properties required. The shaft is extremely strong and virtually unbreakable when used as intended. If however sideways pressure is exerted on the shaft while it is not supported by the side plate bearing it can be bent.

With the drum removed check that the vacuum port is free from blockages and that the dust skirts are in good condition.

Remove all build up and deposits of material from the under side of the drum housing. On certain applications, e.g., the removal of damp self levelling compounds, it may be necessary to clean away deposits hourly! Failure to do so could result in overload of the drum assembly, engine and drive belts.



BEF320-3A
Operating Manual

Cont'd

Height Adjustment Maintenance:

Ensure the height screw thread is cleaned and then lightly oiled. Periodically it should be removed and the female threaded section cleaned out and oiled. At the same time, the self-aligning bearing should be greased.

The clevis pin should be oiled regularly to maintain a light, smooth height adjustment.

BEF320 Cutter Drum Adjustment:

Should the machine be cutting more heavily on one side. Stop engine and adjust lock/nut bolt assembly on top of right-hand side of chassis. By adjusting up or down the cutting action can be reset level again. Retighten all bolts. Test on sample area and if required reset until cutting correctly.

Great care should be taken to ensure belts have correct tension and correct alignment. Serious damage could be caused to the drive shaft, drive shaft bearings and engine if the belts are excessively tight.

Note: Never operate the BEF320 without belt guard fitted

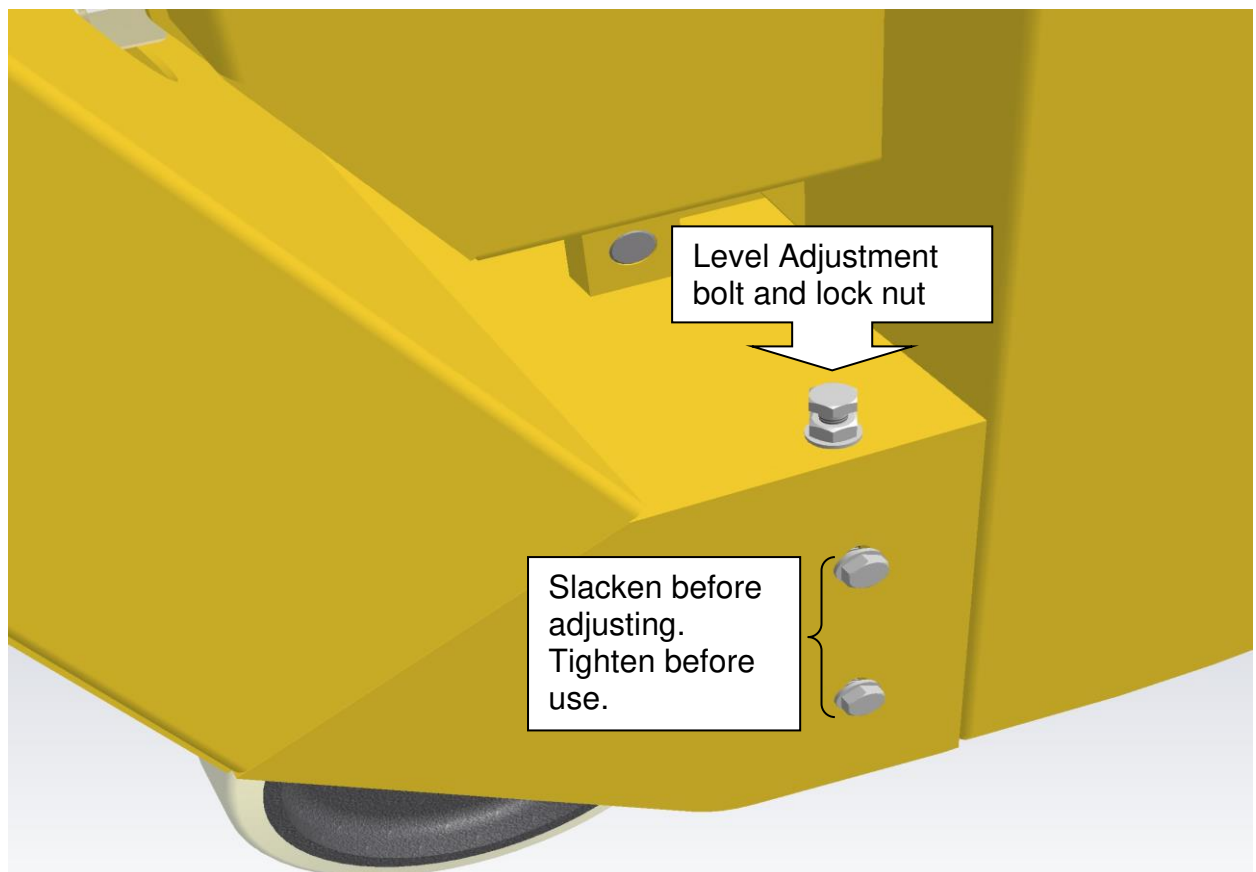



BASIC MAINTENANCE/CHECKLIST

DAILY: (or every 8hrs to 10hrs)

- Check cutters
- Check flail shafts
- Check all bolts and nuts for tightness
- Check belt tension
- Clean air filter elements
- Check engine oil
- Check hydraulic oil level.
- Clean any debris from drum enclosure and ensure drum turns freely.
- See engine manufacturers maintenance details before start engine.

WEEKLY:

- All the above with following:-
- Grease all moving parts on height adjustment mechanism
- Remove side plate
- Check drum/bushes
- Check side plate bearing
- Check drive bushes
- Check drive shaft
- Check support wheels
- Check hydraulic drive system

MONTHLY:

- All the above with following:-
- Change hydraulic oil
- Strip down fully winding mechanism
- Clean all threads and re-grease
- Replace air filter elements



| |
|--------------------------------------|
| BEF320-3A Operating Manual |
|--------------------------------------|

SAFETY

Only trained operatives should be allowed to work the BEF320.

All operatives should wear ear defenders, goggles and an effective dust mask.

Note: It is possible that the noise level produced by the BEF320 could exceed 90dbA. Personal noise protection must be worn.

To control dust it is recommended that an SPE dust control unit/vacuum is fitted.





Never leave the BEF320 unattended while in use. Always stop the engine and set the height adjustment fully up before leaving the machine.

Never remove the side plate or belt guard until the cutter drum has come to a complete standstill. Never tip the machine backwards until the cutters have come to rest.





Never operate the BEF320 inside or in a poorly ventilated area. Carbon monoxide gas is emitted.

Noise and vibration will occur at various levels dependant on the attachments and work being completed. SPE have assessments conducted under test conditions detailed in the operating manual. (See page 24). However, it is recommended that additional tests are taken on site to provide the operator with accurate information on using the equipment within the guidelines laid down by the Health & Safety Executive.

ACCESSORIES

| | Part number | Description | Application |
|---|--------------|--|--|
|  | 32001 | Heavy duty drum complete with T.C.T. cutters and spacers. | Hardened steel cutter with tungsten inserts, for all concrete texturing, scabbling, planing and grooving applications. Removal of bridge deck and car park membranes, heavy industrial contamination, epoxy coatings and road markings. Use on heavy applications for longer life and higher output. |
|  | 32002 | Heavy duty drum complete with beam flails | Heat treated steel cutter for the removal of paint coatings and laitence from new floors. Also used for removing of grease build ups, dirt and ice deposits, keying and light scabbling of concrete when a "fine textured" surface is required. |
|  | 32003 | Heavy duty drum complete with milling cutters and spacers. | For the removal of thermoplastic road/runway markings. Very efficient and cost effective with none of the problems associated with burning off thermoplastics. Also for removal of bituminous materials and rubber deposits. |
|  | 80800 | T.C.T. Cutter: 8 point hardened steel cutter with tungsten carbide insert. | For all concrete texturing scabbling, planing and grooving applications. Removal of bridge deck and car park membranes, heavy industrial contamination, epoxy coatings and road markings. Use on heavy applications for longer life and higher output. |
|  | 80120 | Beam cutter: Heat treated steel cutter. | For the removal of paint coatings and laitence from new floors. Also used for the removing of grease build ups, dirt and ice deposits, keying and light scabbling of concrete when a "fine textured" surface is required. |

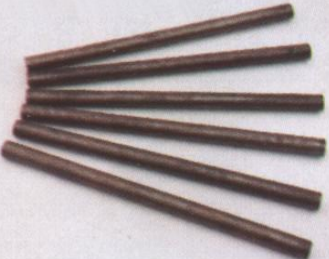
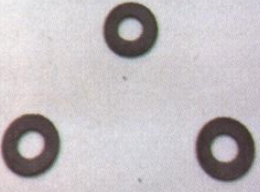
ACCESSORIES

| | | | |
|---|-------------------------------|--|--|
|  | <p>20mm 80600N</p> | <p>Milling cutter: Tipped with tungsten carbide.</p> | <p>For the removal of thermoplastic road/runway markings, rubber based deposits and cold plastic coatings from asphalt and concrete.</p> |
|  | <p>32000</p> | <p>Heavy duty drum complete with flail shafts.</p> | <p>For use with various cutter configurations.</p> |
|  | <p>32020</p> | <p>Heavy duty flail shaft.</p> | <p>Hardened cutter shaft.</p> |
|  | <p>40240</p> | <p>Spacing washer.</p> | <p>Hardened spacing washer.</p> |
|  | <p>3049</p> | <p>Hardened Bush.</p> | <p>Hardened drum inserts to carry flail shafts.</p> |



BEF320-3A
Operating Manual

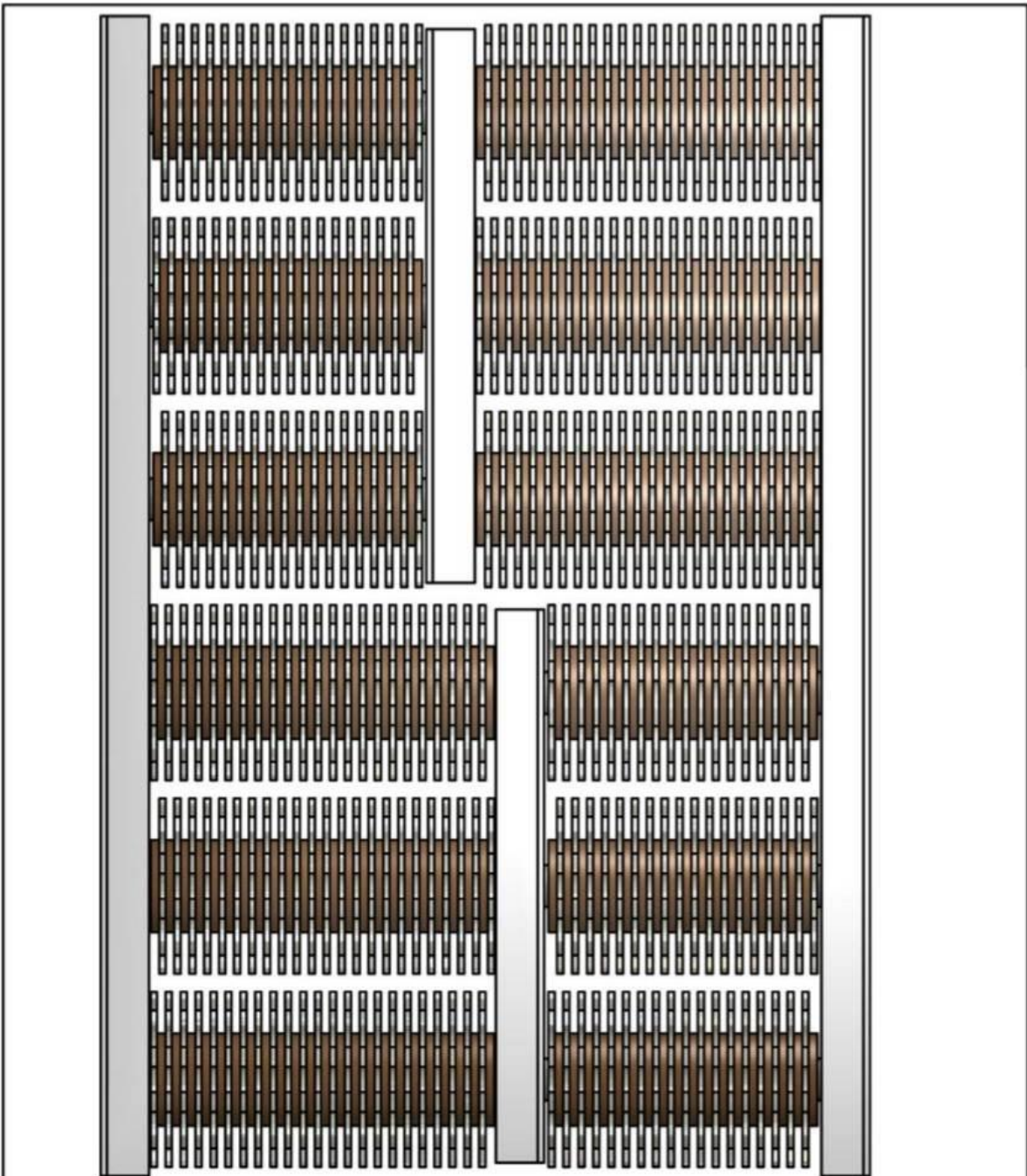

| Parts List | | |
|------------|-------------|-------------|
| QTY | PART NUMBER | DESCRIPTION |
| 246 | 40240 | Spacer |
| 246 | 80120 | Beam Flail |

This drawing should not be used, copied, shown or handed to a third party without the prior written consent of SPE International Ltd.

| | | |
|---|----------------------------|---|
| | | SPE International Limited Honeyholes Lane, Dunholme Lincoln, LN2 2SU, England Tel: +44 (0) 1673 869 799 or +44 (0) 1673 869 330 Fax: +44 (0) 1673 861 119 Web Site: http://www.spe-int.com E-mail: sales@spe-int.com |
| THIS DRAWING IS THE CONFIDENTIAL COPYRIGHT PROPERTY OF SPE INTERNATIONAL LIMITED | | |
| Drawn | TITLE Drum c/w Beam Flails | |
| D.G.A. | | |
| Checked | Drawing No. | MACHINE |
| P.A. | BEF-320_Drum-BF | BEF 320 |



BEF320-3A
Operating Manual

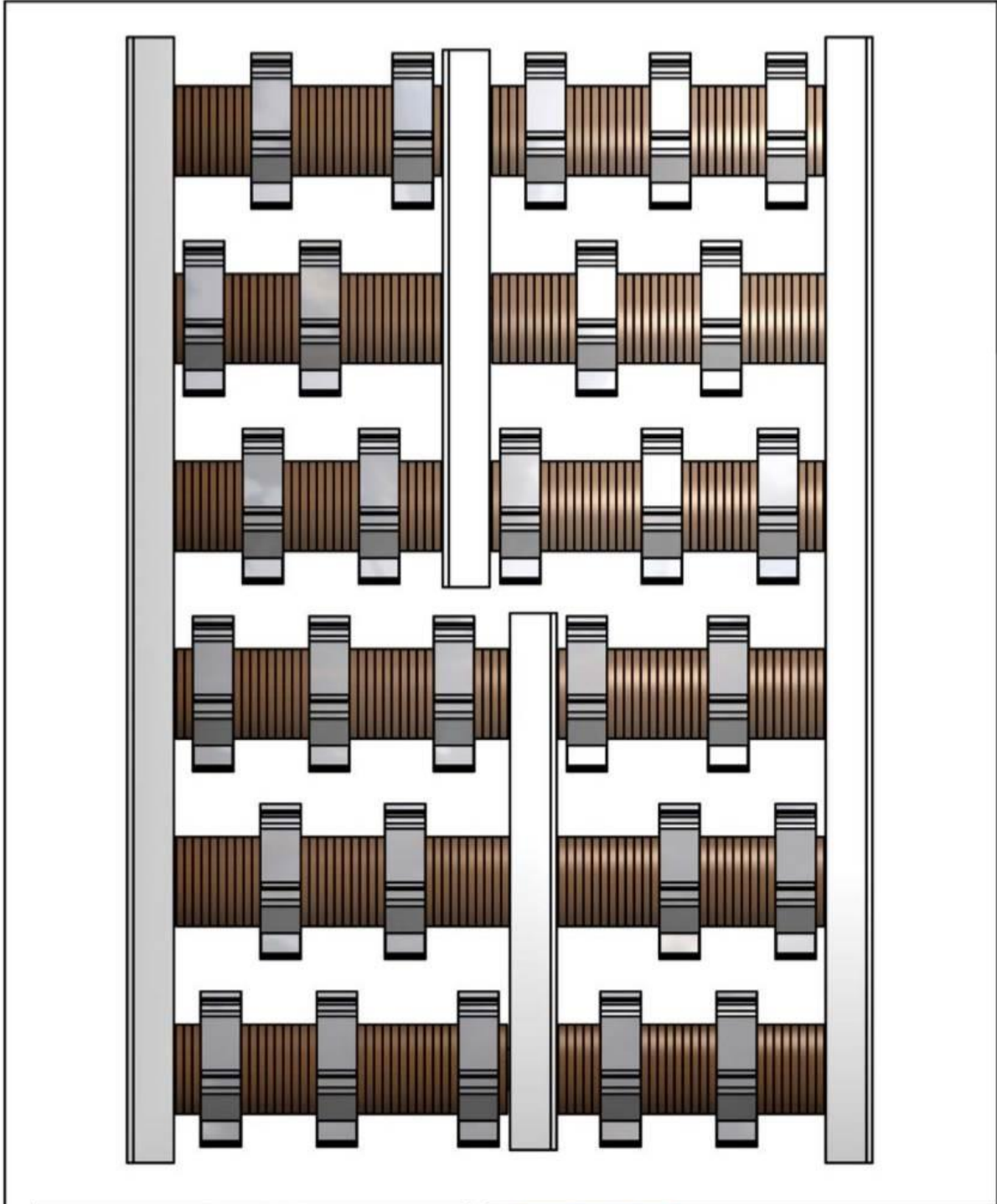

| Parts List | | |
|------------|-------------|----------------|
| QTY | PART NUMBER | DESCRIPTION |
| 292 | 40240 | Spacer |
| 28 | 80600N | Milling Cutter |

This drawing should not be used, copied, shown or handed to a third party without the prior written consent of SPE International Ltd.



SPE International Limited
 Honeyholts Lane, Dunholme
 Lincoln, LN2 3SU, England
 Tel: +44 (0) 1673 860 709
 or +44 (0) 1673 860 330
 Fax: +44 (0) 1673 861 119
 Web Site: <http://www.spe-int.com>
 E-mail: sales@spe-int.com

THIS DRAWING IS THE CONFIDENTIAL COPYRIGHT
PROPERTY OF SPE INTERNATIONAL LIMITED

| | | |
|---------|-----------------------------------|--------------------|
| Drawn | TITLE Drum c/w Milling Cutters | |
| D.G.A. | | |
| Checked | Drawing No. BEF-320_Drum-MC | MACHINE BEF 320 |
| P.A. | | |



BEF320-3A
Operating Manual

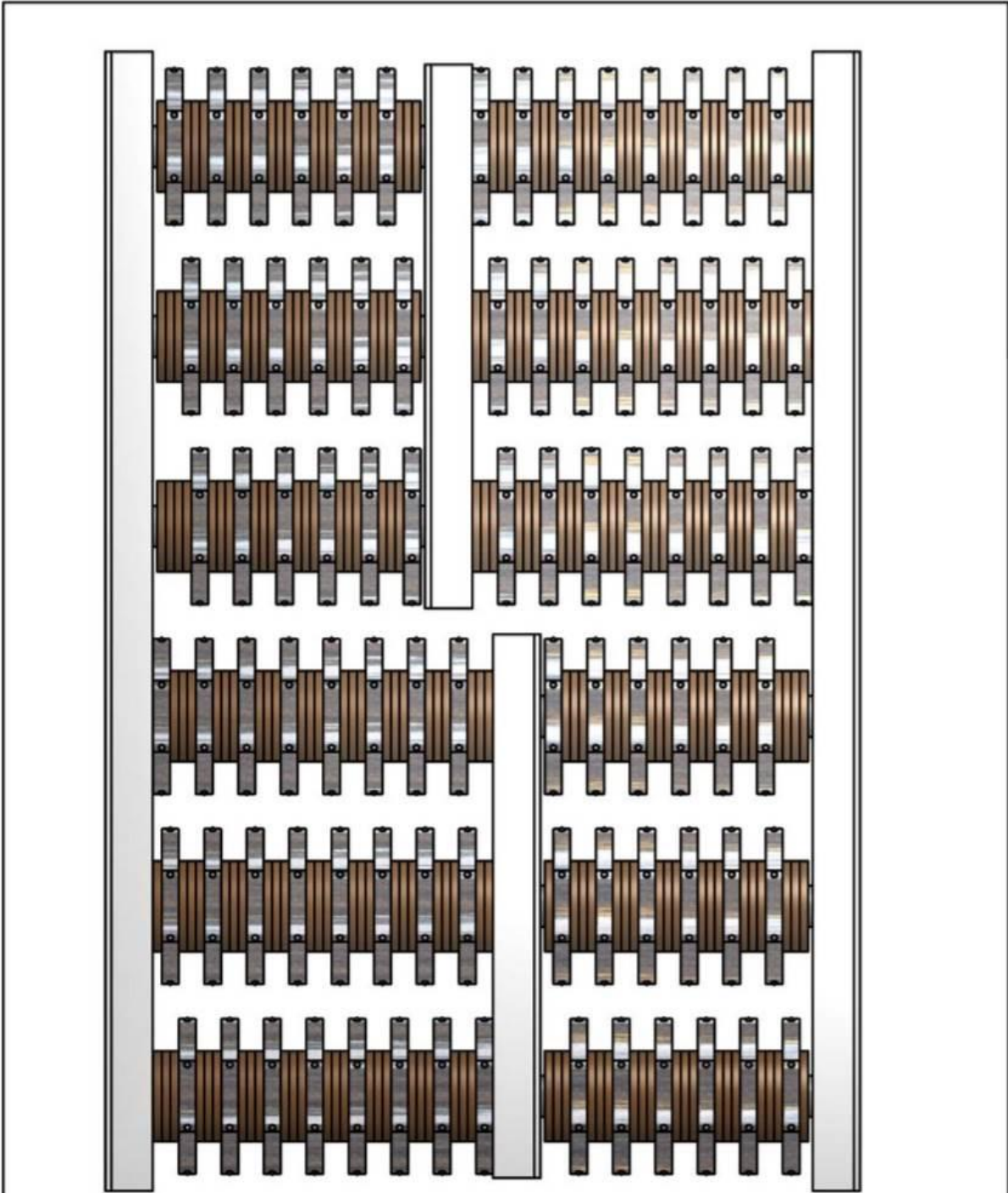

| Parts List | | |
|------------|-------------|-------------|
| QTY | PART NUMBER | DESCRIPTION |
| 258 | 40240 | Spacer |
| 84 | 80800 | TCT Cutter |

This drawing should not be used, copied, shown or handed to a third party without the prior written consent of SPE International Ltd.



SPE International Limited
Honeyholes Lane, Dunholme
Lincoln, LN2 3SU, England
Tel: +44 (0) 1673 960 700
or +44 (0) 1673 960 330
Fax: +44 (0) 1673 961 119
Web Site: <http://www.spe-int.com>
E-mail: sales@spe-int.com

| | | |
|--|--------------------------------------|---------|
| THIS DRAWING IS THE CONFIDENTIAL COPYRIGHT PROPERTY OF SPE INTERNATIONAL LIMITED | | |
| Drawn | TITLE Drum c/w Tungsten Carbide Tips | |
| D.G.A. | | |
| Checked | Drawing No. | MACHINE |
| P.A. | BEF-320_Drum-TCT | BEF 320 |



BEF320-3A
Operating Manual

Spare Parts Breakdown



BEF320-3A
Operating Manual

This drawing should not be used, copied, shown or handed to a third party without the prior written consent of SPE International Ltd.

| ITEM | QTY | SPE PART NUMBER | DESCRIPTION |
|------|-----|-----------------|------------------------------|
| 1 | 1 | 3001 | Main Chassis |
| 2 | 1 | 3002 | Handle |
| 3 | 1 | 3003 | Motor Mounting Plate |
| 4 | 1 | 3017 | T-Bar |
| 5 | 1 | 3025 | Belt Guard |
| 6 | 1 | 3031 | Pump Mounting Plate - Yammar |
| 7 | 1 | 3024 | Swivel Pin |
| 8 | 1 | 3018 | Swivel Pin (T-Bar) |
| 9 | 1 | 3016 | Axle |
| 10 | 1 | 3015 | Front Wheel |
| 11 | 2 | 3022 | Front/Rear Seal |
| 12 | 2 | 3021 | Front/Rear Relining Bar |
| 13 | 2 | 3010 | Side Seal |
| 14 | 2 | 3020 | Relining Bar |
| 15 | 1 | 3081 | Vac Hose |
| 16 | 1 | 3001B | Back Plate |
| 17 | 1 | 3058A | Side Plate |
| 18 | 1 | 3025B | Guard Support Post |
| 19 | 1 | 3082 | Edging Strip |
| 20 | 2 | HC-60 | Hose Clip |

Parts List

| | | | | |
|--|--------|-----------------------|-------------------|------|
| Drawn | D.G.A. | Drawing No. | Checked | P.A. |
| | | BEF-320 Bdy-03 | BEF 320-3A | |
| SPE International Limited Hydrogen Lane, Daresbury Warrington, Cheshire, WA4 4AD Tel: +44 (0) 1972 860 208 Fax: +44 (0) 1972 860 318 Web: www.spe-int.com Email: sales@spe-int.com | | | | |
| THIS DRAWING IS THE CONFIDENTIAL COPYRIGHT PROPERTY OF SPE INTERNATIONAL LIMITED | | | | |
| TITLE: Body Components | | | | |
| MACHINE | | | MACHINE | |

This drawing should not be used, copied, shown or handed to a third party without the prior written consent of SPE International Ltd.

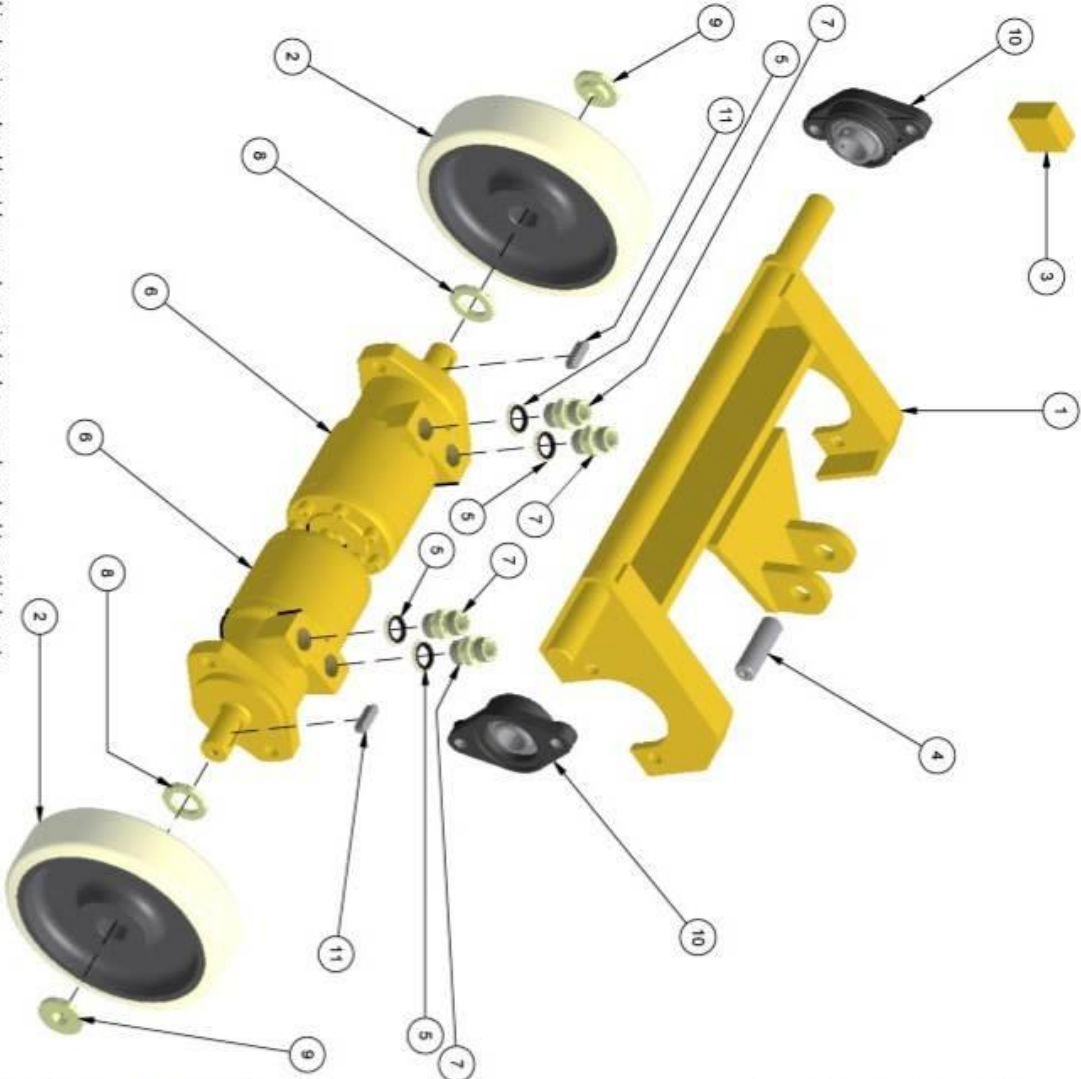

Parts List

| ITEM | QTY | SPE PART NUMBER | DESCRIPTION |
|------|-----|-----------------|-----------------------|
| 1 | 1 | 3004 | Rear Wheel Bracket |
| 2 | 2 | 07034 | Wheel |
| 3 | 1 | 3014A | Bearing Block |
| 4 | 1 | 3009 | Hyd. Ram Pin |
| 5 | 4 | DW/08 | 1/2" Downy Washer |
| 6 | 2 | 09009 | Wheel Motor |
| 7 | 4 | ADAPT 003 | 1/2" m-m Hyd. Adaptor |
| 8 | 2 | 07035A | Spacer Washer |
| 9 | 2 | 07035 | Hub Cap |
| 10 | 2 | 3014 | Flange Bearing |
| 11 | 2 | 9131 | Bx30 Parallel Key |

Surface Preparation Equipment™
THIS DRAWING IS THE CONFIDENTIAL COPYRIGHT PROPERTY OF SPE INTERNATIONAL LIMITED
Undercarriage Components

Drawn: D.G.A.
 Checked: P.A.

Drawing No: BEF-320_Unc-03
 MACHINE: BEF 320-3A

SPE International Limited
 Registered Office: 10000
 London, EC2G 3BL, England
 Tel: +44 (0) 1873 860 730
 Fax: +44 (0) 1873 860 730
 Email: sales@spe-int.com
 Web: www.spe-int.com

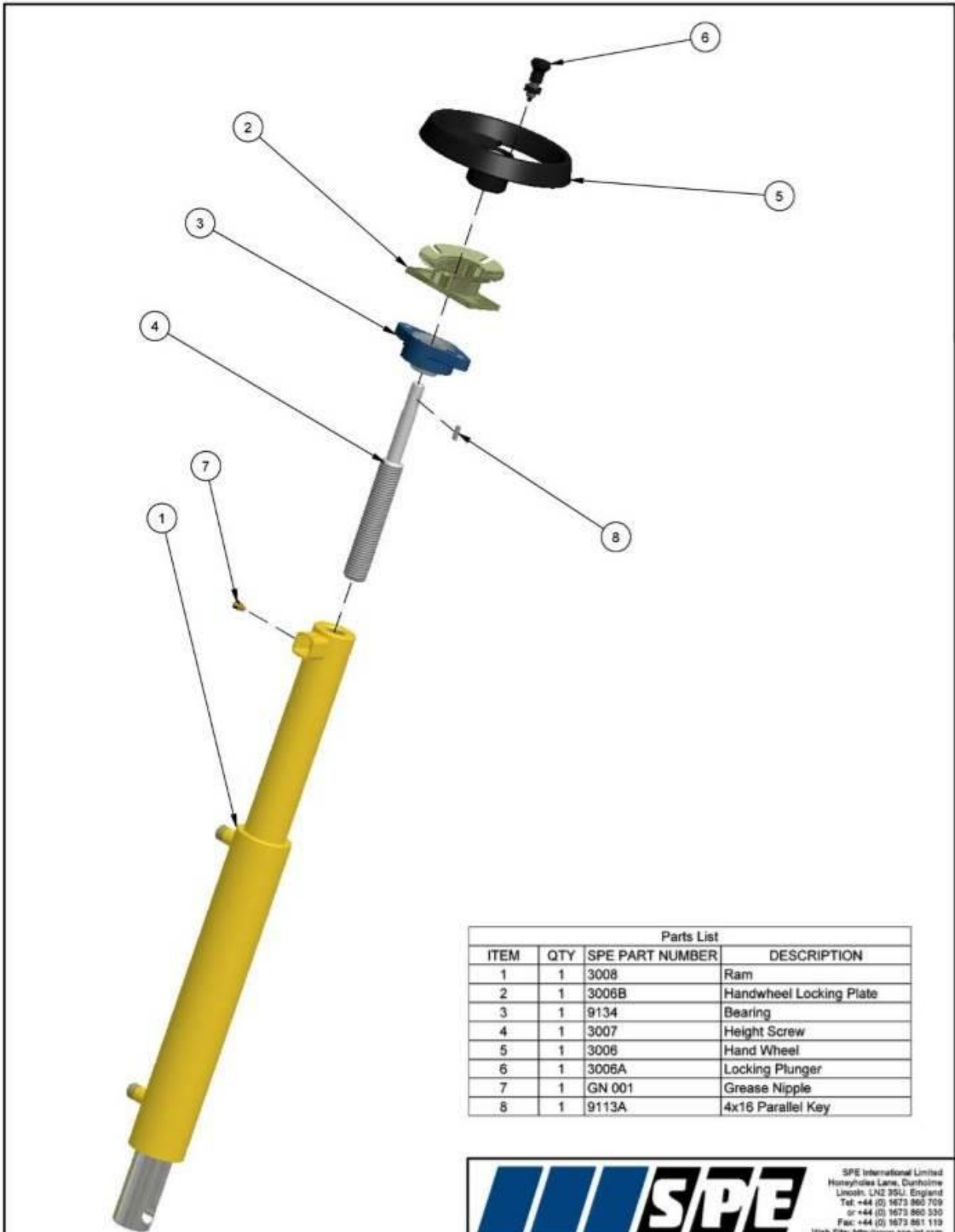

| Parts List | | | |
|------------|-----|-----------------|-------------------------|
| ITEM | QTY | SPE PART NUMBER | DESCRIPTION |
| 1 | 1 | 3008 | Ram |
| 2 | 1 | 3006B | Handwheel Locking Plate |
| 3 | 1 | 9134 | Bearing |
| 4 | 1 | 3007 | Height Screw |
| 5 | 1 | 3006 | Hand Wheel |
| 6 | 1 | 3006A | Locking Plunger |
| 7 | 1 | GN 001 | Grease Nipple |
| 8 | 1 | 9113A | 4x16 Parallel Key |



SPE International Limited
Honeyholes Lane, Dunholme
Lincoln LN2 3SU, England
Tel: +44 (0) 1673 860 709
or +44 (0) 1673 860 330
Fax: +44 (0) 1673 861 119
Web Site: <http://www.spe-int.com>
E-mail: sales@spe-int.com

| | | |
|---|----------------------------------|------------|
| THIS DRAWING IS THE CONFIDENTIAL COPYRIGHT PROPERTY OF SPE INTERNATIONAL LIMITED | | |
| Drawn | TITLE Height Adjuster Components | |
| D.G.A. | | |
| Checked | Drawing No. | MACHINE |
| P.A. | BEF-320_HAd-03 | BEF 320-3A |

This drawing should not be used, copied, shown or handed to a third party without the prior written consent of SPE International Ltd.

BEF320-3A
Operating Manual

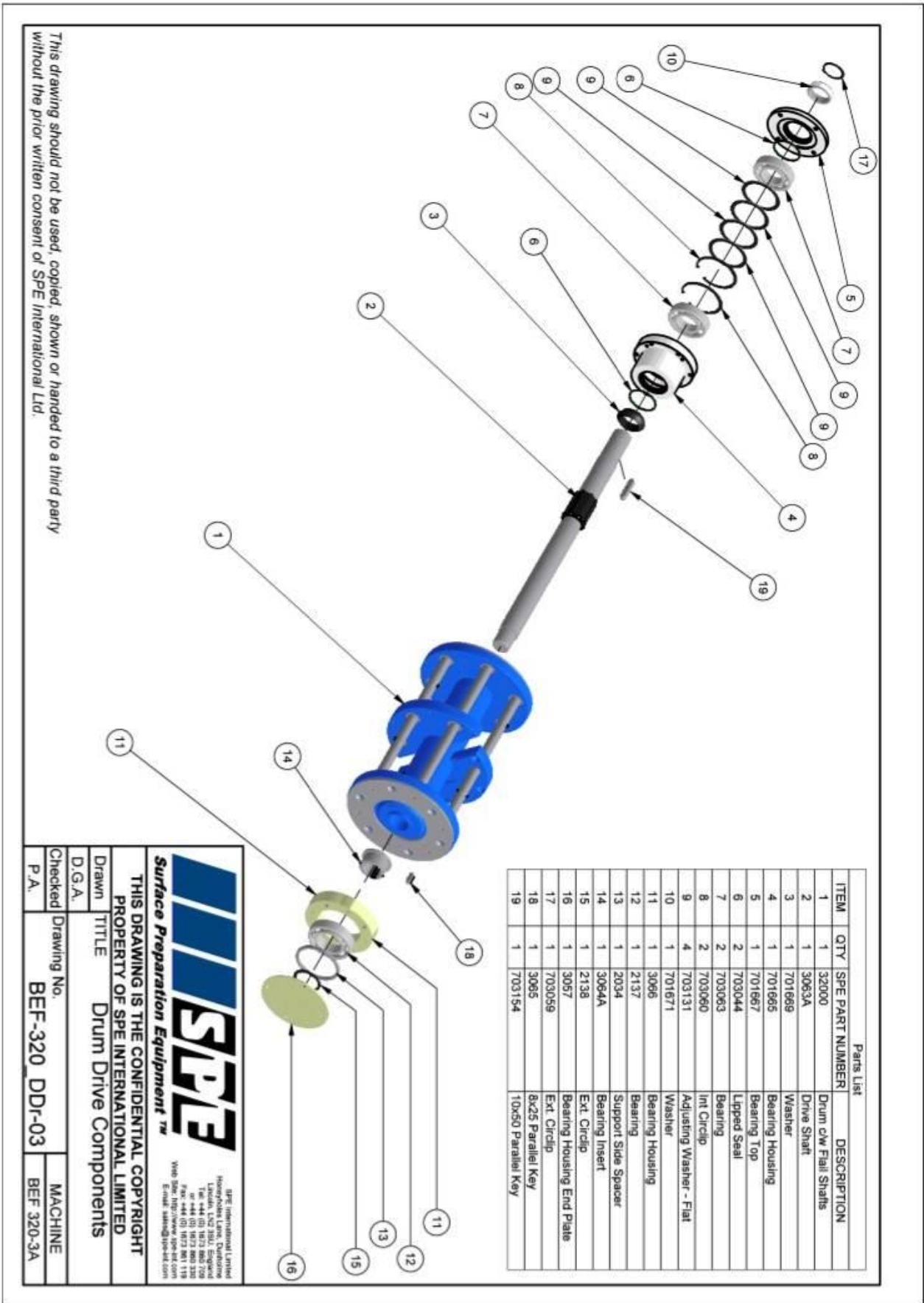

Surface Preparation Equipment™

THIS DRAWING IS THE CONFIDENTIAL COPYRIGHT PROPERTY OF SPE INTERNATIONAL LIMITED

Drawn TITLE Drum Drive Components
D.G.A.
Checked P.A.

Drawing No. BEF-320 DD-03 MACHINE BEF 320-3A

SPE International Limited
Huddersfield, England
Tel: +44 (0) 1473 860 709
Fax: +44 (0) 1473 860 708
Email: sales@spe-intl.com

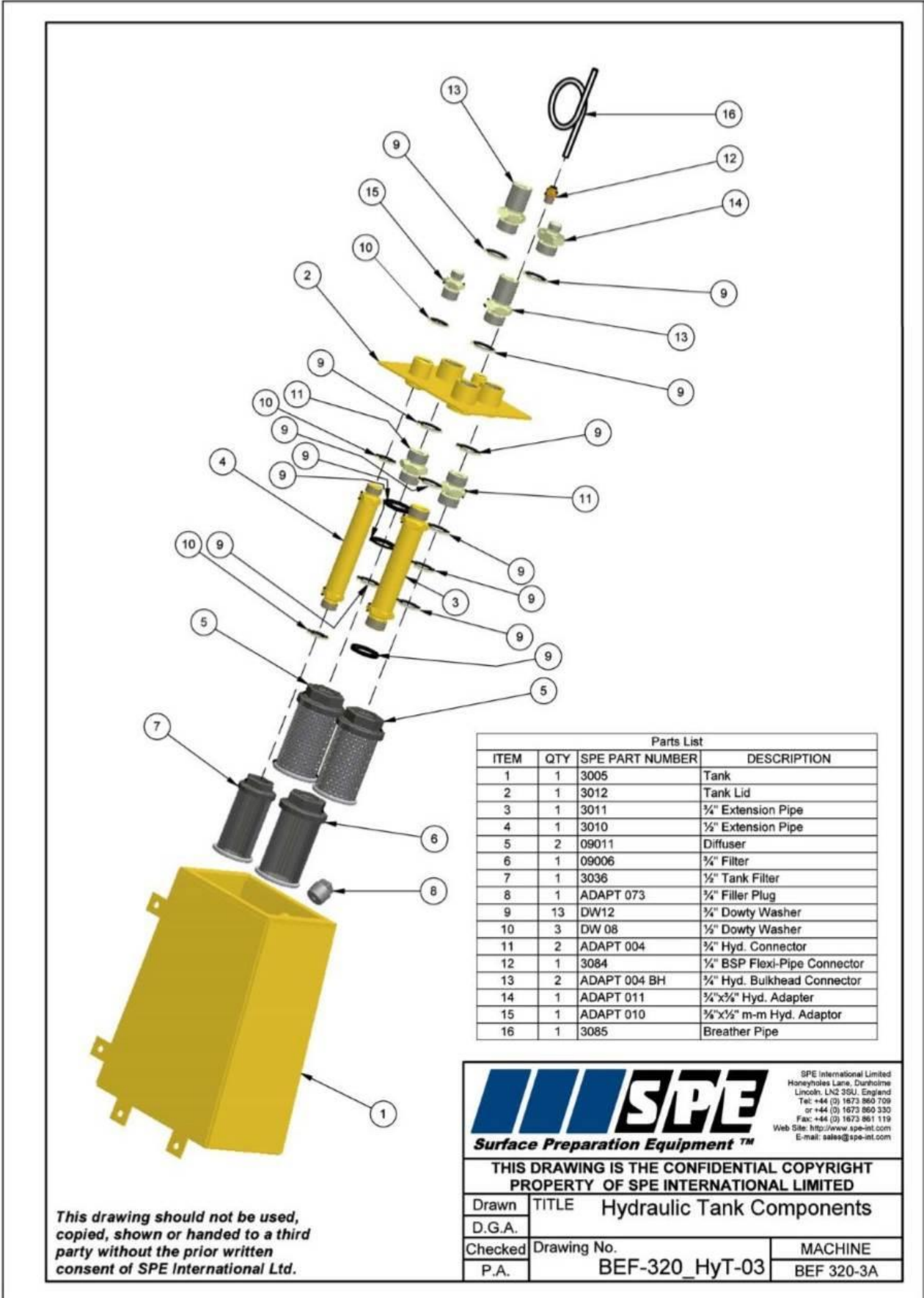

| Parts List | | | |
|------------|-----|-----------------|-------------------------------|
| ITEM | QTY | SPE PART NUMBER | DESCRIPTION |
| 1 | 1 | 3005 | Tank |
| 2 | 1 | 3012 | Tank Lid |
| 3 | 1 | 3011 | 3/4" Extension Pipe |
| 4 | 1 | 3010 | 1/2" Extension Pipe |
| 5 | 2 | 09011 | Diffuser |
| 6 | 1 | 09006 | 3/4" Filter |
| 7 | 1 | 3036 | 1/2" Tank Filter |
| 8 | 1 | ADAPT 073 | 3/4" Filler Plug |
| 9 | 13 | DW12 | 3/4" Dowty Washer |
| 10 | 3 | DW 08 | 1/2" Dowty Washer |
| 11 | 2 | ADAPT 004 | 3/4" Hyd. Connector |
| 12 | 1 | 3084 | 1/4" BSP Flexi-Pipe Connector |
| 13 | 2 | ADAPT 004 BH | 3/4" Hyd. Bulkhead Connector |
| 14 | 1 | ADAPT 011 | 3/4"x3/4" Hyd. Adapter |
| 15 | 1 | ADAPT 010 | 3/4"x1/2" m-m Hyd. Adaptor |
| 16 | 1 | 3085 | Breather Pipe |



SPE International Limited
Honeyholes Lane, Dunholme
Lincoln LN2 3SU, England
Tel: +44 (0) 1673 860 709
or +44 (0) 1673 860 330
Fax: +44 (0) 1673 861 119
Web Site: <http://www.spe-int.com>
E-mail: sales@spe-int.com

| | | |
|---|---------------------------------|------------|
| THIS DRAWING IS THE CONFIDENTIAL COPYRIGHT PROPERTY OF SPE INTERNATIONAL LIMITED | | |
| Drawn | TITLE Hydraulic Tank Components | |
| D.G.A. | | |
| Checked | Drawing No. | MACHINE |
| P.A. | BEF-320_HyT-03 | BEF 320-3A |

This drawing should not be used, copied, shown or handed to a third party without the prior written consent of SPE International Ltd.

This drawing should not be used, copied, shown or handed to a third party without the prior written consent of SPE International Ltd.

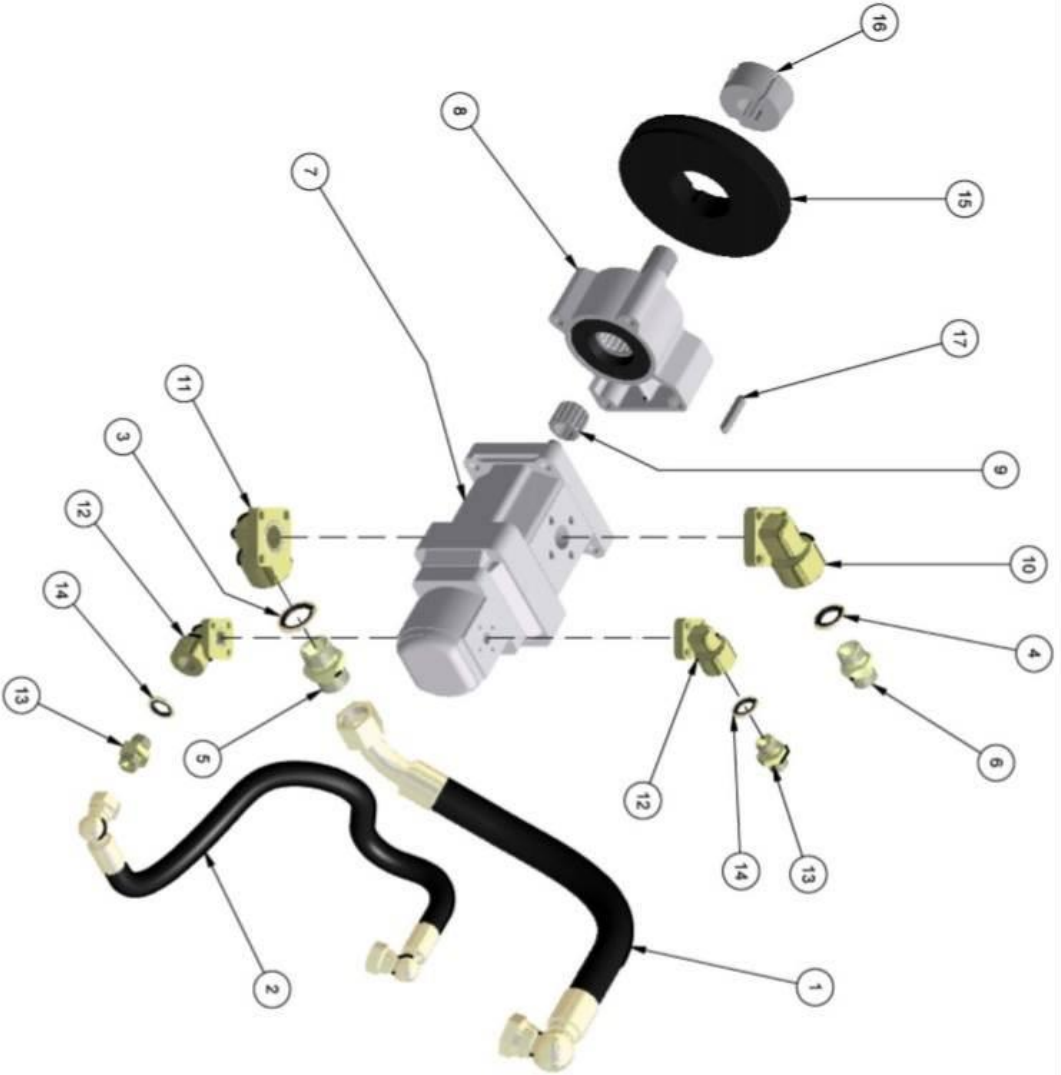

| Parts List | | | |
|------------|-----|-----------------|--------------------------------|
| ITEM | QTY | SPE PART NUMBER | DESCRIPTION |
| 1 | 1 | 3041 | Hyd Pipe, Tank to Pump |
| 2 | 1 | 3046 | Hyd Pipe, Tank to Pump |
| 3 | 1 | DW12 | 1/2" Dowty Washer |
| 4 | 1 | DW 06 | 1/2" Dowty Washer |
| 5 | 1 | ADAPT 004 | 1/2" Hyd Connector |
| 6 | 1 | ADAPT 003 | 1/2" m-m Hyd Adaptor |
| 7 | 1 | 3035 | Tandem Pump |
| 8 | 1 | 3033 | Load Adaptor |
| 9 | 1 | 3034 | Splined Drive |
| 10 | 1 | 3035B | 1/2" Port Connector c/w O-Ring |
| 11 | 1 | 3035C | 1/2" Port Connector c/w O-Ring |
| 12 | 2 | 3035A | 1/2" Port Connector c/w O-Ring |
| 13 | 2 | ADAPT 002 | 1/2" m-m Hyd Adaptor |
| 14 | 1 | DW 06 | 1/2" Dowty Washer |
| 15 | 1 | 3030 | Driven Pulley |
| 16 | 1 | 3029 | Taper Lock Bush (1610 - 22mm) |
| 17 | 1 | 3033A | 6x39 Parallel Key |

SPE International Limited
Henrietta Lane, Dunstable
Luton, LN2 3UL, England
Tel: +44 (0) 1473 660 739
Fax: +44 (0) 1473 660 738
E-mail: sales@spe-int.com

THIS DRAWING IS THE CONFIDENTIAL COPYRIGHT
PROPERTY OF SPE INTERNATIONAL LIMITED

TITLE Hydraulic Drive Components

| | | | |
|---------|--|----------------|------------|
| Drawn | | Drawing No. | |
| D.G.A. | | BEF-320_HDI-03 | MACHINE |
| Checked | | P.A. | BEF 320-3A |

BEF320-3A
Operating Manual

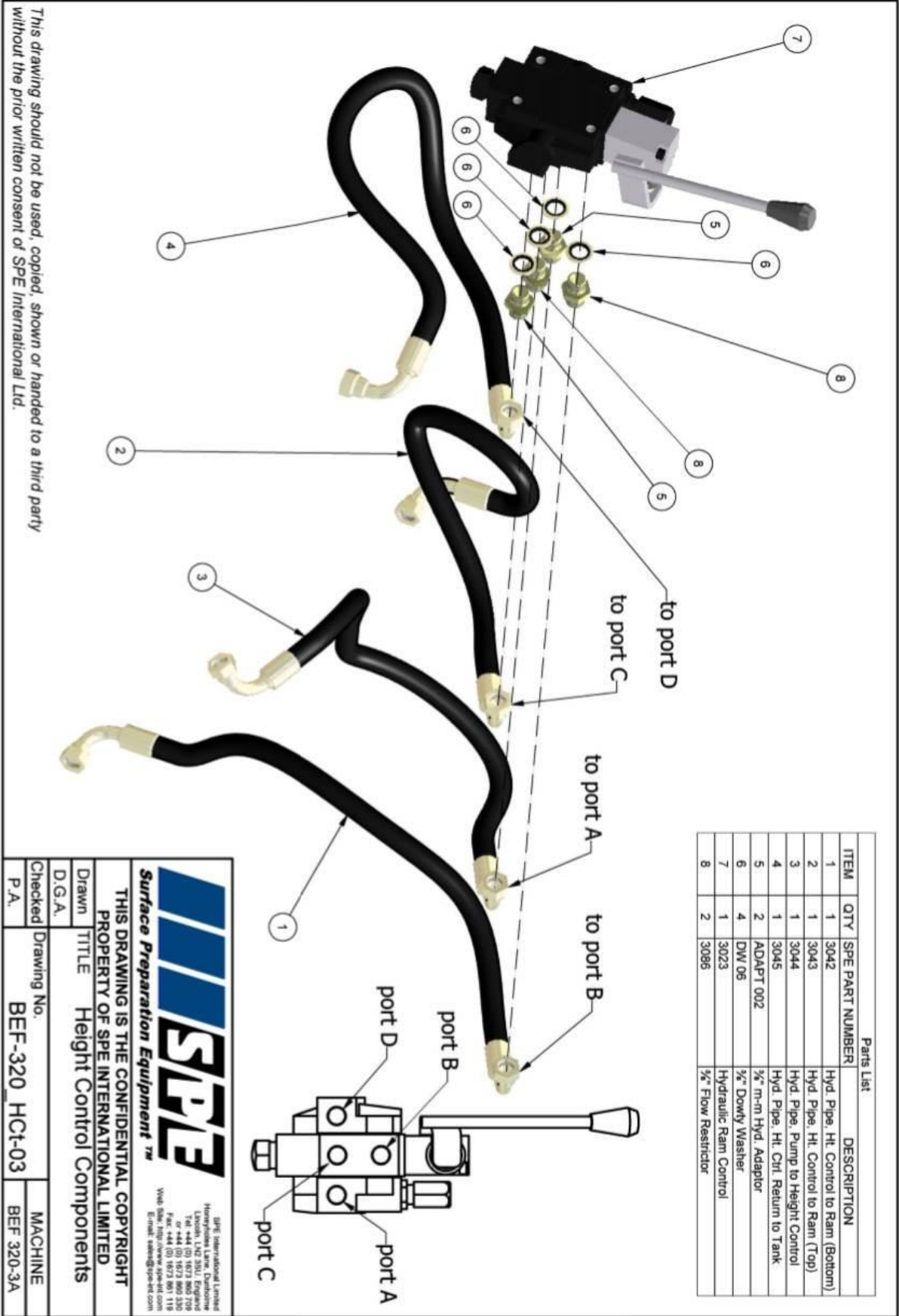

This drawing should not be used, copied, shown or handed to a third party without the prior written consent of SPE International Ltd.

Surface Preparation Equipment™

THIS DRAWING IS THE CONFIDENTIAL COPYRIGHT PROPERTY OF SPE INTERNATIONAL LIMITED

Drawn TITLE Height Control Components
D.G.A.
Checked P.A.

Drawing No. BEF-320_HCt-03
MACHINE BEF 320-3A

SPE International Limited
Horspitten Lane, Dorking
London, UK 201, England
Tel: +44 (0) 1873 800 709
Fax: +44 (0) 1873 800 320
Web: www.spe-int.com
Email: sales@spe-int.com

BEF320-3A
Operating Manual

Parts List

| ITEM | QTY | SPE PART NUMBER | DESCRIPTION |
|------|-----|-----------------|--|
| 1 | 1 | 3009 | Hyd. Pipe, Pump to Drive Control |
| 2 | 1 | 3040 | Hyd. Pipe, Drive Control to Tank |
| 3 | 6 | DW 06 | 5/8" Drinky Washer |
| 4 | 6 | ADAPT 005 | 1/2" mtr Hyd. Adaptor |
| 5 | 1 | 02010 | Hydraulic Drive Control |
| 6 | 1 | ADAPT 013 | 5/8"x1/2" Hyd. Adapter |
| 7 | 2 | 3005 | Hyd. Pipe, Dr. Cnt. to Lith Wheel Motor |
| 8 | 2 | 3057 | Hyd. Pipe, Dr. Cnt. to Right Wheel Motor |

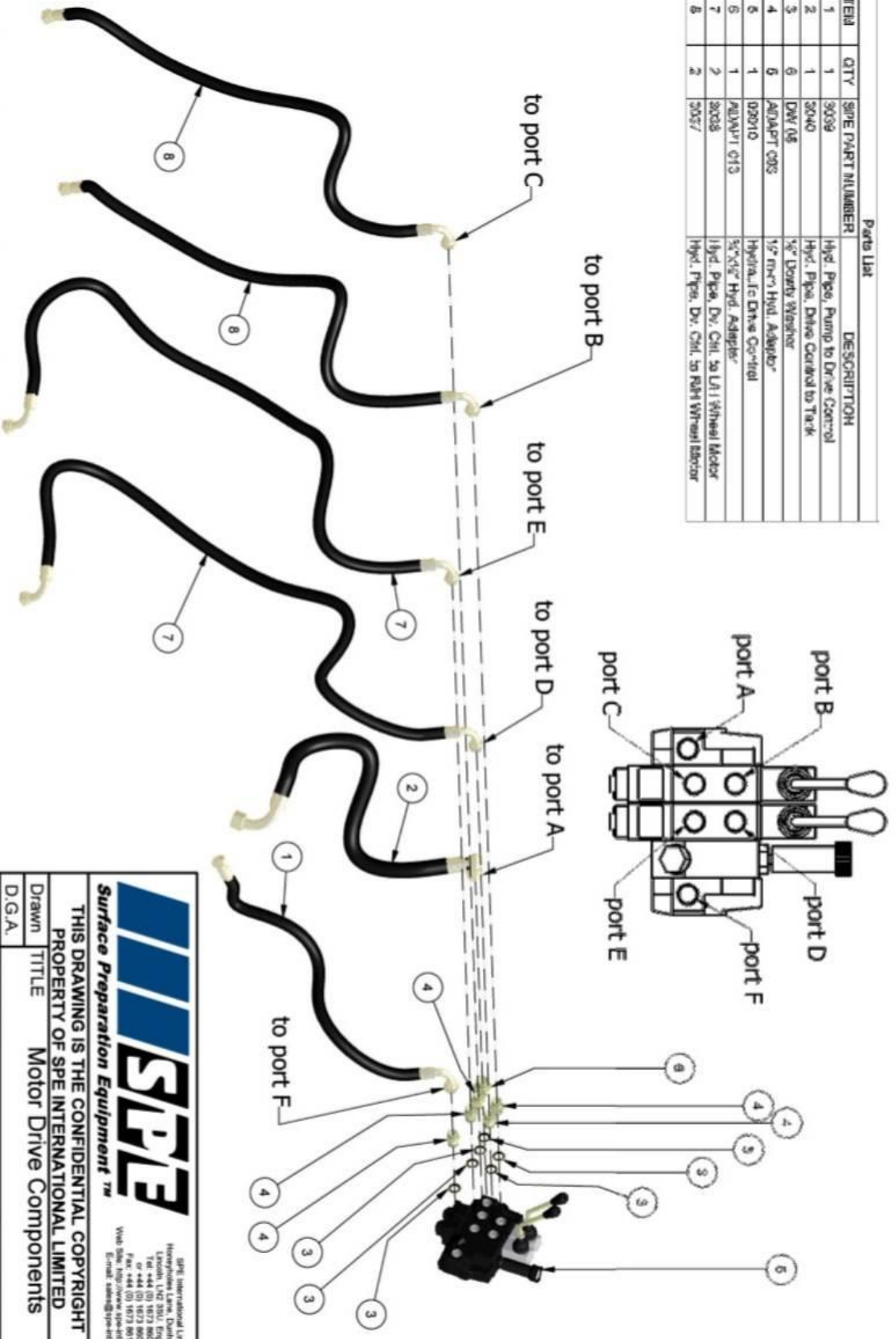

This drawing should not be used, copied, shown or handed to a third party without the prior written consent of SPE International Ltd.

Surface Preparation Equipment™

THIS DRAWING IS THE CONFIDENTIAL COPYRIGHT PROPERTY OF SPE INTERNATIONAL LIMITED

TITLE: **Motor Drive Components**

Drawn: _____

D.G.A.

Checked: _____

P.A.

SPE International Limited

High Wycombe, Bucks, England

Unit 10, The Mill, Mill Lane

High Wycombe, Bucks HP12 3RQ

Tel: +44 (0) 1494 600 330

Fax: +44 (0) 1494 601 118

Web: <http://www.spe-int.com>

E-mail: sales@spe-int.com

Drawing No. **BEF-320_MDR-03**

MACHINE **BEF 320-3A**



BEF320-3A
Operating Manual

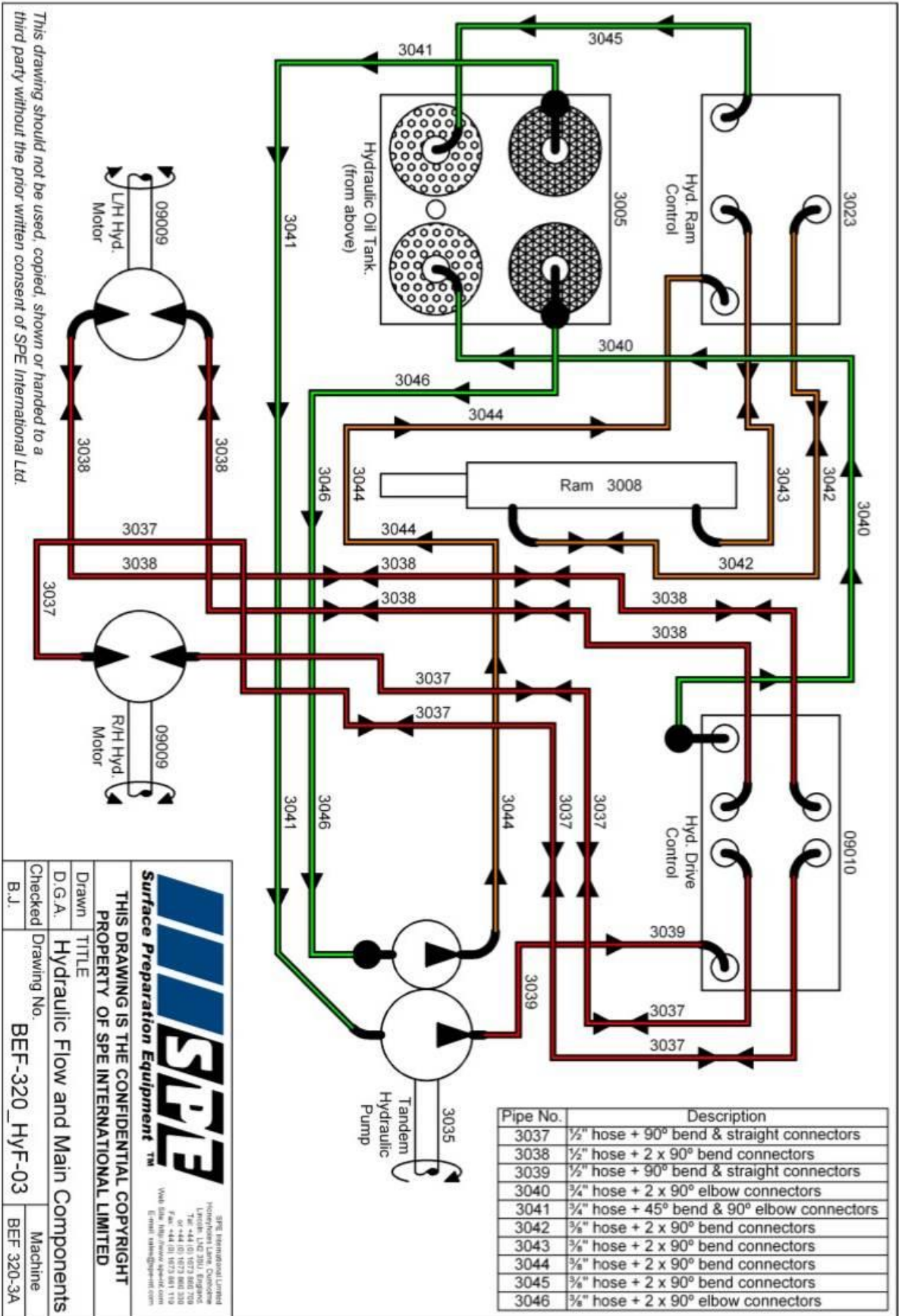

SPE International Limited
Hydro-Pneum Lark, Churchway
Lanark, LG2 3JL, England
Tel: +44 (0) 1873 882 330
Fax: +44 (0) 1873 881 119
Web Site: <http://www.spe-int.com>
E-mail: sales@spe-int.com

Surface Preparation Equipment™

THIS DRAWING IS THE CONFIDENTIAL COPYRIGHT PROPERTY OF SPE INTERNATIONAL LIMITED

| | | | |
|---------|--------|-------------|------------------------------------|
| Drawn | D.G.A. | TITLE | Hydraulic Flow and Main Components |
| Checked | B.J. | Drawing No. | BEF-320_HYF-03 |
| | | Machine | BEF 320-3A |

| ITEM | QTY | SPE PART NUMBER | DESCRIPTION |
|------|-----|-----------------|--------------------------------------|
| 1 | 1 | 3047 | Pulley |
| 2 | 1 | 3048 | Taper Lock Bush (3020 - 38mm) |
| 3 | 1 | 3089 | Beating Housing |
| 4 | 1 | 2136/ | Rolling Bearing |
| 5 | 1 | 3032 | Drive Pulley |
| 6 | 1 | 3088 | Boobin |
| 7 | 1 | 3074 | Inner Air Filter Element |
| 8 | 1 | 3075 | Outer Air Filter Element |
| 9 | 1 | 3026Y-HP | Drive Belt |
| 10 | 1 | 3091 | Yanmar Diesel Engine |
| 11 | 5 | 3026 Y | Drive Belt (Robins Engine) |
| 11 | 5 | 3026 | Drive Belt (Yanmar Engine) |
| 12 | 4 | HC-60 | Hose Clip |
| 13 | 1 | 3077 | Air Filter Elbow |
| 14 | 1 | 3090 | Flex Pipe |
| 15 | 1 | 3078 | Metal Sleeve |
| 16 | 1 | 3073 | Remote Air Filter Body (w/ Elements) |
| 17 | 1 | 3072 | Tube Pre-Cleaner |

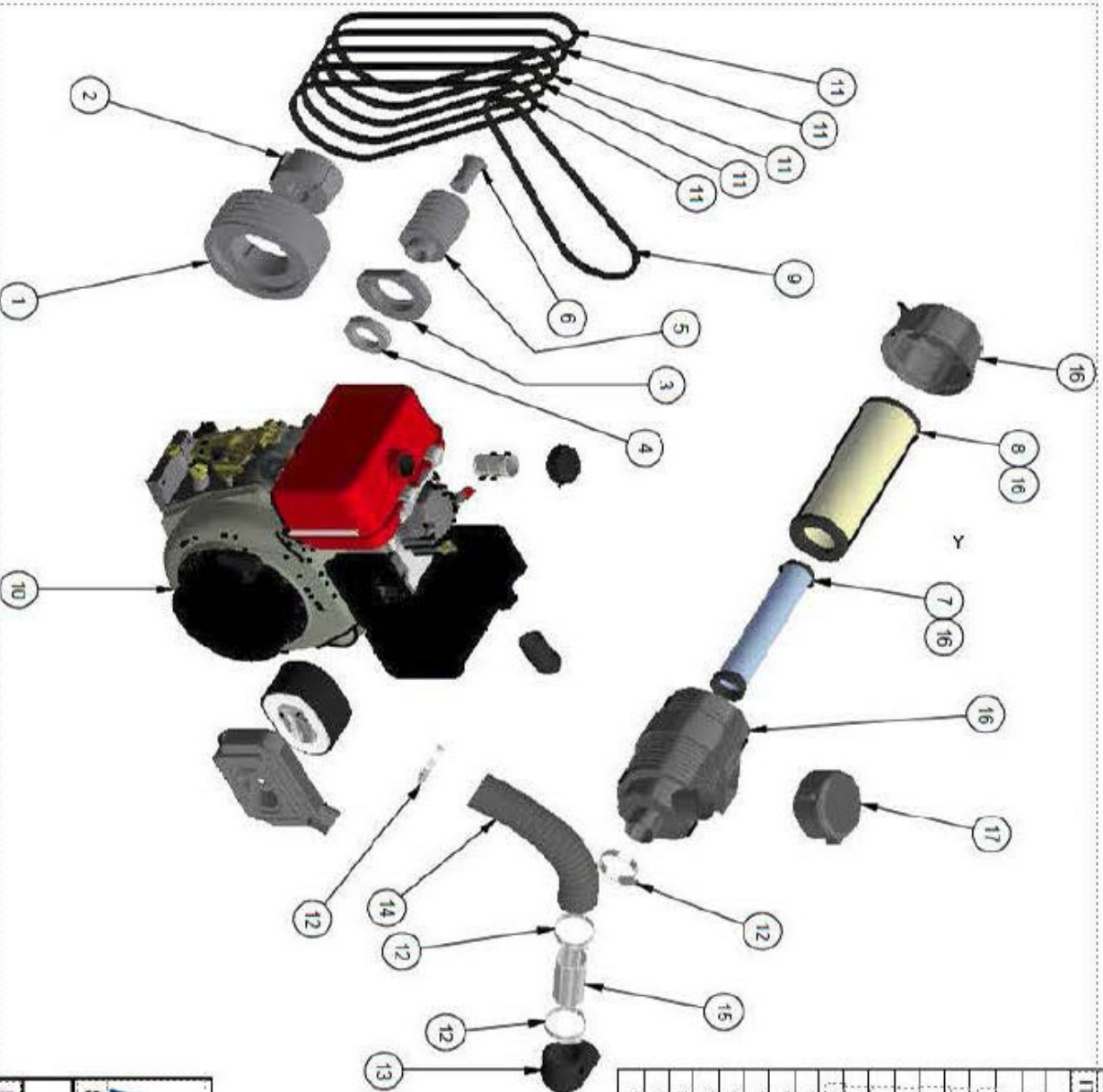

This drawing should not be used, copied, shown or handed to a third party without the prior written consent of SPE International Ltd

Surface Preparation Equipment™

THIS DRAWING IS THE CONFIDENTIAL COPYRIGHT PROPERTY OF SPE INTERNATIONAL LIMITED

DRAWN TITLE: **Engine Components**

D.G.A.

Checked Drawing No. **BEF-320 END-03**

P.A. MACHINE **BEF-320-3A**



SPE International Limited
 Honeyford Lane, Donnington
 London, UK SW9L 6JG
 Tel: +44 (0) 203 989 026
 Fax: +44 (0) 203 989 026
 Email: sales@spe-int.com

Parts List:

SPECIFICATION SHEET

| Specifications | |
|---------------------------------|-----------|
| Type | Diesel |
| Part Number | BEF320-3A |
| Power Output (hp) | 10 |
| Voltage | |
| Cycles | |
| Cutter head speed (rpm) | 650 |
| Starter | Manual |
| Travel speed mtr/min | 0-12 |
| Machine Dimensions (mm) | |
| Length | 1230 |
| Width | 590 |
| Height | 1220 |
| Weight (kg) | 319 |
| c/w cutter drum | |
| Working width of cutters (mm) | 320 |
| Working distance from wall (mm) | 40 |

RECORD OF NOISE AND VIBRATION ASSESSMENT

| | |
|---------------------|------------------------|
| Manufacturer: | |
| Type: | Scarifier |
| Model No. | BEF 320-3A Diesel |
| Motor: | Yanmar |
| Operation : | Concrete floor surface |
| Inserted Tool: | TCT cutters |
| Running Conditions: | 1800 rpm |
| HAV Note: | Acoustic Associates |

HAND-ARM VIBRATION

Frequency Weighted Energy Equivalent Accelerations ($a_{h,w}$)

| Measurement Position | Acceleration (m/s^2) |
|----------------------|--------------------------|
| | Vector Sum |
| Handle | 7.805 |

NOISE LEVELS

Sound Power Level (L_{WA})

| L_{WA} at Octave Band Centre Frequency (Hz) | | | | | | | | Sound Power Level L_{WA} |
|---|------|------|-------|-------|-------|-------|------|----------------------------|
| 63 | 125 | 250 | 500 | 1000 | 2000 | 4000 | 8000 | |
| 83.8 | 94.1 | 98.6 | 105.4 | 106.9 | 105.3 | 101.0 | 94.8 | 111.6 |

Operator's Ear

| $L_{Aeq,T}$ at Octave Band Centre Frequency (Hz) | | | | | | | | Overall Level ($L_{Aeq,T}$) | L_{Peak} dB(C) |
|--|------|------|------|------|------|------|------|-------------------------------|------------------|
| 63 | 125 | 250 | 500 | 1000 | 2000 | 4000 | 8000 | | |
| 68.6 | 77.5 | 81.3 | 91.6 | 93 | 89.3 | 85.5 | 79.2 | 96.3 | 111.25 |





WARRANTY

The standard warranty period of this equipment is **12 months** from the date below in accordance with the company Conditions of Sale (copy attached).

| | |
|-----------------------------|-------------------------|
| <i>Warranty start date:</i> | As despatch date |
| <i>Model:</i> | BEF320-3A |
| <i>Serial no:</i> | |
| <i>Customer name:</i> | |
| <i>Customer Address:</i> | |
| | |
| | |
| | |
| | |
| | |

| | |
|----------------------|---|
| <i>Manufacturer:</i> | SPE International Ltd |
| | Honeyholes Lane |
| | Dunholme |
| | Lincoln |
| | LN2 3SU |
| | England |
| <i>Telephone:</i> | +44 (0) 1673 860709 |
| <i>Fax:</i> | +44 (0) 1673 861119 |
| <i>Email:</i> | sales@spe-int.com |
| <i>Web site:</i> | www.spe-int.com |

Distributor:



BEF320-3A
Operating Manual

| | |
|--|--|
| EN Declaration of Incorporation | FR Certificat de incorporation |
| NL Integratie certificaat | ES Declaración de Incorporación |
| PT Declaração de Incorporação | IT Dichiarazione Di Fabbricante Secondo Allegato IIB Della Direttiva Macchine 2006/42/EC |
| DE Einbauerklärung | |

We: Bartell Morrison Inc.
170 Traders Blvd
Mississauga, Ontario, Canada
L4Z 1W7
Tel: 647-953-4100

EN Declare under our sole responsibility that the product to which this declaration relates is in conformity with the following standard(s) or other normative documents.

FR Déclarons sous notre responsabilité que le produit cette déclaration est conforme aux normes suivantes ou d'autres documents habituels.

NL Verklaan onder onze verantwoordelijkheid dat het product naar welke de verklaring verwijst conform de volgende standaards of anders gebruikelijke documenten is.

ES Declaramos bajo nuestra única responsabilidad que el producto en lo que esta declaración concierne, es conforme con la siguiente normativa u otros documentos.

PT Declara sob sua responsabilidade que o produto a quem esta declaração interessar, está em conformidade com os seguintes documentos legais ou normas directivas.

IT Dichiariamo sotto la ns. unica responsabilità che il prodotto al quale questa dichiarazione si riferisce, è fabbricato in conformità ai seguenti standard e documenti di normative.

DE Erklärt hiermit, dass das der Erklärung zugeordnete Produkt den wesentlichen Schutzanforderungen entspricht, die in den nachfolgend bezeichneten Richtlinien festgelegt sind.

| | |
|-------------------|---|
| EN 349:1993 | Safety of Machinery - Minimum gaps to avoid crushing of parts of the human body. |
| EN ISO 13850:2006 | Safety of Machinery - Emergency stop equipment - Principles for design |
| EN ISO 12100 | Safety of Machinery – General principles for design – Risk assessment and risk reduction |
| EN ISO 3744 | Acoustics — Determination of sound power levels and sound energy levels of noise sources using sound pressure — Engineering methods for an essentially free field over a reflecting plane |

EN Following the provisions of Directive(s):

FR Suivant les directive(s) déterminées:

NL Volgens de vastgestelde richtlijnen:

ES Siguiendo las directiva(s):

PT No seguimento das clausulas da Directiva(s):

IT Seguendo quanto indicato dalla Direttiva(s):

DE Gemäß den Bestimmungen der Direktive(n):

| | |
|------------|---|
| 2006/42/EC | Machinery Directive |
| 2001/95/EC | General Product Safety Directive |
| 2000/14/EC | Noise Emission in the Environment Directive |

EN This partially complete machinery must not be put into service until it has been assembled according to our instructions and the final machinery has been declared in conformity with the provisions of the applicable directives.

FR Ces machines partiellement complètes ne doivent pas être mises en service jusqu'à ce qu'elles aient été assemblées selon nos instructions et les machines finales ont été déclarées conformément aux dispositions des directives applicables.

NL Deze gedeel telijk volledige machines moeten niet in gebruik worden genomen tot het volgens onze instructies is geassembleerd en de defini tieve machines in overeenstemming met de bepalingen van de toepasselijke richtlijnen zijn verklaard.



BEF320-3A
Operating Manual

- ES** Esta maquinaria parcialmente completa no se debe poner en servicio hasta que ha estado montada según nuestras instrucciones y la maquinaria final se ha declarado en conformidad con las provisiones de los directorios aplicables.
- PT** Esta maquinaria parcialmente completa não deve ser posta no serviço até que esteja montada de acordo com nossas instruções e a maquinaria final estiver declarada no conformity com as provisões das diretrizes orientadoras aplicáveis.
- IT** Inol tre si dichiara che non è consenti to mettere in servizio il macchinario fino a che la macchina in cui sarà incorporato e di cui diverrà componente, non sia stata dichiarata conforme alle disposizioni del la direttiva 2006/42/EC.
- DE** Diese nicht vollständige Maschine darf erst nach dem in der Anleitung beschriebenen Zusammenbau aller Komponenten in Betrieb genommen werden. Die Konformitätserklärung gilt nur für die vollständige Maschine.

- EN** Technical Characteristics:
FR Caractéristiques techniques:
NL Technisch gegevens:
ES Características Técnicas:
PT Características Técnicas:
IT Qualitàs di tecnico:
DE Technische Daten:

| | |
|--|---|
| EN Model FR Modèle NL Type ES Modelo PT Modelo IT Modello DE Modell | FR Numéro de Série machine NL Seriennummer machine ES Máquina número de série PT Numero de serie da maquina IT Numero di seria la macchina DE Seriennummer |
| Machine: BEF320 Multiplane | Model: BEF320-3A |

- EN** The Technical Construction file is maintained at:
FR Les fiches techniques de construction sont gardées à:
NL Het technische constructie document wordt bewaard te:
ES El archivo técnico de construcción se mantiene en:
PT O arquivo técnico de construção é mantido no (a):
IT L'originale dossier tecnico di costruzione è conservato presso:
DE Die technischen Dokumentationen befinden sich in:

Bartell Morrison Inc.
170 Traders Blvd.
Mississauga, Ontario, Canada
L4Z 1W7
Telephone: 647-953-4100

- EN** The authorized representative is:
FR Le représentant autorisé est:
NL Gemachtigd vertegenwoordiger is:
ES La representación autorizada es:
PT O representante autorizado é:
IT Il rappresentate autorizzato:
DE Die verantwortliche Person ist:

Mr. John Hill
Group VP Bartell Global EOMA
SPE International Ltd.
Honeyholes Lane
Dunholme, Lincoln, United Kingdom
LN2 3SU
Telephone: +44 (0)1673 860709
Facsimile: +44 (0)1673 861119



BEF320-3A
Operating Manual

EN Signature of Authorized Person:
FR Signature de la personne autorisée:
NL Handtekening van gemachtigd persoon:
ES Firma de la persona autorizada:
PT Assinatura de pessoa autorizada:
IT Firma della persona autorizzata:
DE Unterschrift der verantwortlichen Person:

A handwritten signature in black ink, appearing to read 'E. Campbell', is written over a horizontal line.

Eric Campbell
Engineering Manager

EN Typed name of Authorized Person:
FR Nom dactyographié de la personne autorisée:
NL Getypte naam van gemachtigd persoon:
ES Nombre de la persona autorizada:
PT Nome datilografado da pessoa autorizada:
IT Nome della persona autorizzata:
DE Gedruckter Name der verantwortlichen Person:

3/31/2021
Louisville, Kentucky

EN Title of Authorized Person:
FR Titre de la personne autorisée:
NL Functie van gemachtigd persoon:
ES Cargo de la persona autorizada:
PT Título da pessoa autorizada:
IT Posizione della persona autorizzata:
DE Funktion der verantwortlichen Person:

EN Date and place of issue:
FR Date et place d'émission:
NL Datum en plaats van afgifte:
ES Fecha y lugar de emisión:
PT Data e lugar de emissão:
IT Data e luogo di emissione:
DE Ausstellungsort und -Datum:



BEF320-3A
Operating Manual

CONDITIONS OF SALE

The quotation overleaf and any order placed following such quotation are subject to the following conditions of sale in which SPE International Limited is referred to as the "Company".

- 1. Validity of quotation**
No order received from a customer by the Company shall constitute a contract until accepted in writing by the Company.
- 2. Prices**
Prices quoted by the Company are firm for 30 days only or until previously withdrawn. Unless otherwise stated all prices are exclusive of any applicable Value Added Tax for which the customer shall be additionally liable to the Company.
- 3. Delivery**
Delivery periods and dates are given in good faith but are not the subject of any warranty or condition and time shall not be of the essence of the contract in these respects. No liability will attach to the Company if delivery periods or dates are not met for any reason whatsoever.
- 4. Payment**
Save as may otherwise be agreed in writing the customer shall pay the price in full on or before the estimated delivery date whereupon the Company shall raise a receipted invoice. Each invoice includes an Overdue Account Levy of 5% of the total invoice value inclusive of VAT. Subject to payment in full being made on or before the due date a sum equal to the Overdue Account Levy shall be credited to the customer's account with the Company. Until such time as payment in full has been made the Company shall be under no obligation to allow or effect of any goods to the customer.
- 5. Warranty**
The Company warrants that all goods supplied by it will correspond to their specifications and will be free from defects in materials or workmanship for a period of 12 months from the date of delivery. The Company's obligation in the event of a breach of this warranty is limited to the repair or replacement of any defective goods which shall be returned at the cost and expense of the customer to the Company. This warranty is given in lieu of all the other warranty or conditions expressed or implied (whether by statute or otherwise) and is subject to the following conditions:-
 - 5.1** Claims must be notified in writing to the Company within seven days from the date of delivery or (where the defect is not apparent on reasonable inspection) as soon as practicable after discovery of the defect.
 - 5.2** The Company shall be under no liability in respect of any defect in the goods arising from any drawing, design or specification supplied by the customer.
 - 5.3** The Company shall be under no liability if the defect or failure in the reasonable opinion of the Company arises from wilful damage or misuse, negligence by the customer or any third party. Failure to follow the Company instructions, usage of non-recommended parts and materials, alteration or repair of the goods without the prior approval of the Company or non-recommended maintenance.
 - 5.4** The Company shall be under no liability if the price for the goods has not been paid by the due date for payment.
 - 5.5** The above warranty does not extend to:-
 - 5.5.1** Parts, materials or equipment not manufactured by the company in respect of which the customer shall be entitled only to the benefit of any such warranty or guarantee as is given by the manufacturer to the Company.
 - 5.5.2** Any component part of the goods or associated parts coming into contact with abrasive elements or dust within surface Preparation equipment.
 - 5.5.3** Fair wear and tear of moving parts within the goods.
 - 5.6** Except in the case of death or personal injury caused by the Company negligence, the Company shall not be liable for any consequential loss or damage (whether for loss of profit or otherwise) or other claims for consequential compensation.
- 6. Carriage**
Packing, carriage and insurance charges in respect of delivery of the goods to the customer will be charged to the customer at cost to the company.
- 7. Damage in Transit**
The company does not accept any liability for loss or damage to the goods while in transit to the customer.
- 8. Risk**
The risk in the goods shall pass to the customer on delivery to the customer or (if earlier) when possession of the goods is taken by a carrier for delivery to the customer.
- 9. Force Majeure**
The Company shall not be liable to the customer or be deemed to be in breach of any contract with the customer by reason of any delay in performing or any failure to perform any obligation of the Company obligation in relation to the goods if the delay or failure was due to force majeure or to any other cause beyond the Company's reasonable control.
- 10. Reservation of Title**
The goods sold under these conditions shall remain the absolute property of the Company and legal title in the goods shall remain vested in the Company until payment in full of all amounts invoiced or due to the Company in respect of the goods. If the customer shall enter into liquidation have a winding up order made against it or have a Liquidator, receiver, administrator or administrator receiver shall be appointed over its assets, income or any part thereof before the property in the goods has passed in accordance with this condition the Company shall be entitled immediately after giving notice of its intention to repossess any goods to enter upon the premises of the customer with such transport as may be necessary and to repossess any goods to which it has title under this condition. No liquidator, receiver, administrator or administrative receiver of the customer shall have authority to sell goods to which the Company has title without the prior written consent of the Company.
- 11. Insolvency of Customer**
If the customer being a body corporate, shall pass a resolution or suffer an order of the Court to be made for winding – up, or if a Receiver, Administrator or Administrative Receiver shall be appointed or, being an individual or partnership, shall suspend payment, propose or enter into any composition or arrangement with his or their creditors, or have a bankruptcy order made against him or them, then the Company shall have the right, without prejudice to any other contract with the customer, not to proceed further with the contract and shall be entitled to charge for work already carried out (whether completed or not) and for goods and materials already purchased for the customer such charge to be an immediate debt due from the customer.
- 12. Patent Rights, etc**
The acceptance of a quotation includes the recognition by the customer of the Company under any patents, trademarks, registered designs or other intellectual property rights relating to the goods and the customer undertakes that patent numbers, trademarks or other trade markings on goods supplied shall not be obliterated, altered or defaced.
- 13. Applicable Law**
These conditions shall be governed by and construed in accordance with English law and parties acknowledge and accept the exclusive jurisdiction of the English Courts.